

DIM.	TOL.
5mm DOWN	±0.2
5~20mm	±0.3
20~40mm	±0.4
40~60mm	±0.5
60~100mm	±0.8
100mm UP	±1.0

REVISIONS			
REV	DESCRIPTION	DATE	BY

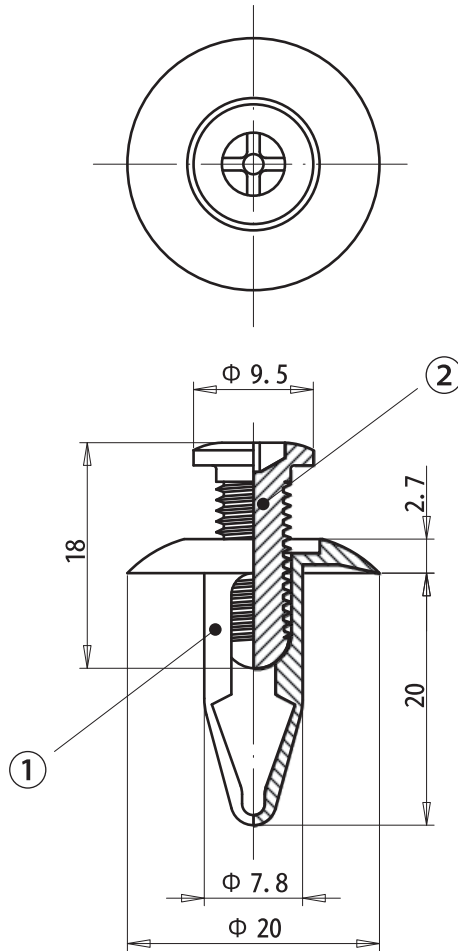

Hole Diam:  $\varnothing 8.0$   
 Panel Thickness: 3.5 - 4.5



				TITLE PUSH SCREW RIVET		
				MATERIAL 1 PA6 UL94V-2	DATE 15/09/2015	
				MATERIAL 2 POM UL94HB	DRAWN S.P.	
PART NUMBER 10515AA01		DRAWING NUMBER 15.09.15.10515.0.E		COLOR BLACK		CHECK
SIZE A4	SCALE 5:3	UNIT mm	REV A	UNLESS OTHERWISE SPECIFIED TOLERANCE SEE ABOVE		APPROVED