

REVISIONS			
REV	DESCRIPTION	DATE	BY

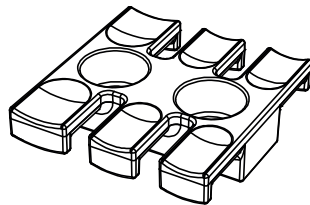

BRASS BUSHINGS

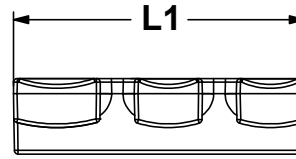
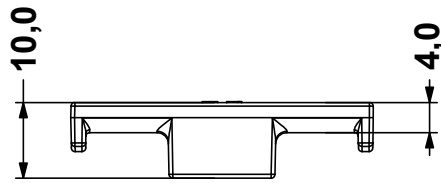
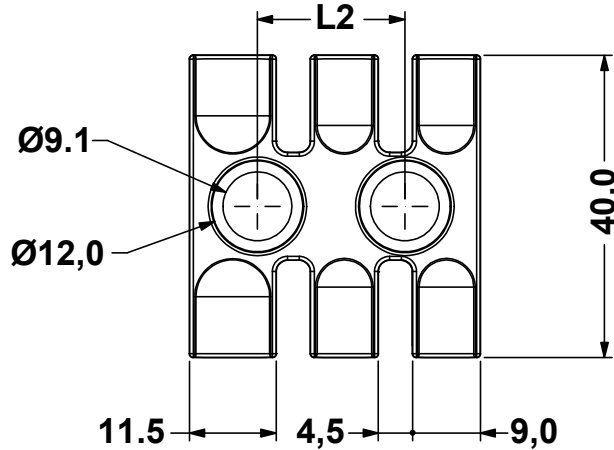
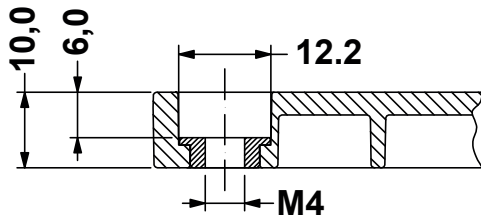

P/N	P/N SUPPLIER	L1	L2	Teeth
16355AA01	1733022403	38,5	19,5	3
16356AA01	1733022404	59,5	43,5	4
16357AA01	1733022405	69,1	43,5	5
16358AA01	1733022406	86,5	68,0	6
16359AA01	1733022407	102,5	84,0	7
16360AA01	1733022408	121,0	102,5	8
16361AA01	1733022409	139,5	121,0	9
16362AA01	1733022410	180,0	157,0	12

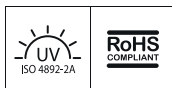

Flammability: UL94-V0, self-extinguishing
 Temperature: -40°C ... +140°C
 Properties: halogen-free, silicone-free



TITLE STRAIN RELIEF MODULES FOR SCREW FIXING	
MATERIAL PA 66	DATE 04/10/2019
COLOR BLACK	DRAWN R.F.
PART NUMBER SEE TABLE	CHECK
DRAWING NUMBER 19.10.04.163XX.0.E	APPROVED
SIZE A4	UNLESS OTHERWISE SPECIFIED TOLERANCE SEE ABOVE
SCALE 1:1	UNIT mm.
REV A	