

DIM.	TOL.
5mm DOWN	±0.2
5~20mm	±0.3
20~40mm	±0.4
40~60mm	±0.5
60~100mm	±0.8
100mm UP	±1.0

REVISIONS			
REV	DESCRIPTION	DATE	BY

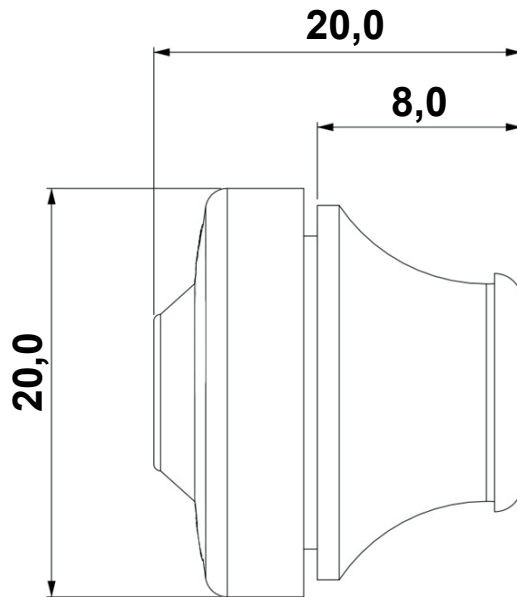

WORKING TEMPERATURE: -40°C ~ +100°C
CUTOUT: PG7
IP RATING: IP67
FLAMMABILITY: V0 (UL94)
NO. OF CABLE LEAD-THROUGHS: 1
CABLE Ø 3,0 - 5,0 mm
HOLE DIAMETER: Ø 13,0 mm
THICKNESS: 1,0 - 4,0 mm

P/N RAL 7035	P/N RAL 9005
18744PS117035	18744PS019005

				TITLE CABLE GROMMET IP67	
				MATERIAL TPE V0 (UL94)	DATE 23/02/2024
PART NUMBER 18744PS				DRAWN E.B.	
				DRAWING NUMBER 24.02.23.18744.0.E	
SIZE A4				COLOR SEE ABOVE	
				CHECK	
SCALE NTS		UNIT mm.		REV A	
UNLESS OTHERWISE SPECIFIED TOLERANCE SEE ABOVE				APPROVED	