

DIM.	TOL.
5mm DOWN	±0.2
5~20mm	±0.3
20~40mm	±0.4
40~60mm	±0.5
60~100mm	±0.8
100mm UP	±1.0

REVISIONS			
REV	DESCRIPTION	DATE	BY

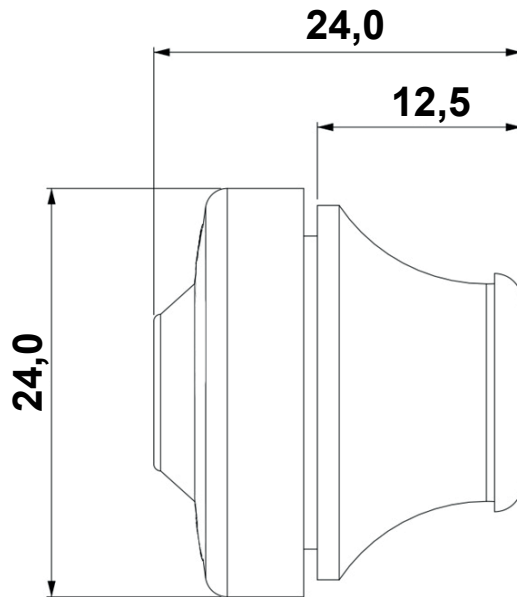

WORKING TEMPERATURE: -40°C ~ +100°C
CUTOUT: PG11
IP RATING: IP67
FLAMMABILITY: V0 (UL94)
NO. OF CABLE LEAD-THROUGHS: 1
CABLE Ø 7,0 - 10,0 mm
HOLE DIAMETER: Ø 19,0 mm
THICKNESS: 1,0 - 4,0 mm

P/N RAL 7035	P/N RAL 9005
18746PS117035	18746PS019005

		TITLE CABLE GROMMET IP67	
		MATERIAL TPE V0 (UL94)	DATE 07/05/2024
PART NUMBER 18746PS		DRAWN E.B.	
DRAWING NUMBER 24.05.07.18746.0.E		CHECK	
SIZE A4	SCALE NTS	COLOR SEE ABOVE	APPROVED
UNIT mm.	REV A	UNLESS OTHERWISE SPECIFIED TOLERANCE SEE ABOVE	