

DIM.	TOL.
5mm DOWN	±0.2
5~20mm	±0.3
20~40mm	±0.4
40~60mm	±0.5
60~100mm	±0.8
100mm UP	±1.0

REVISIONS			
REV	DESCRIPTION	DATE	BY

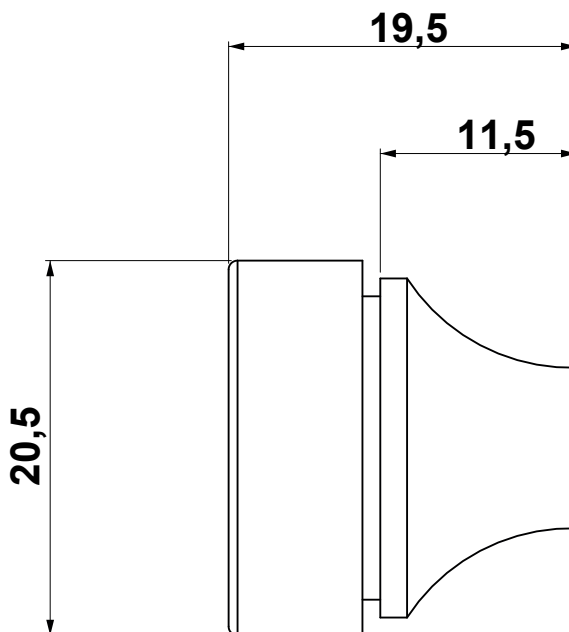

**WORKING TEMPERATURE: -40°C ~ +120°C**  
**SIZE: PG9**  
**PROPERTIES: HALOGEN-FREE**  
**IP RATING: IP67**  
**NO. OF CABLE LEAD-THROUGHS: 1**  
**CABLE Ø 5,0 - 7,0 mm**  
**HOLE DIAMETER: Ø 16,0 mm**  
**THICKNESS: 1,0 - 4,0 mm**

P/N RAL 7035	P/N RAL 9005
18761GS117035	18761GS019005

				TITLE <b>CABLE GROMMET IP67</b>	
				MATERIAL EPDM	DATE 23/02/2024
PART NUMBER 18761GS				DRAWN E.B.	
				DRAWING NUMBER 24.02.23.18761.0.E	
SIZE A4				COLOR SEE ABOVE	
				CHECK	
SCALE NTS				UNLESS OTHERWISE SPECIFIED TOLERANCE SEE ABOVE	
				APPROVED	
UNIT mm.				REV A	