

DIM.	TOL.
5mm DOWN	±0.2
5~20mm	±0.3
20~40mm	±0.4
40~60mm	±0.5
60~100mm	±0.8
100mm UP	±1.0

REVISIONS			
REV	DESCRIPTION	DATE	BY

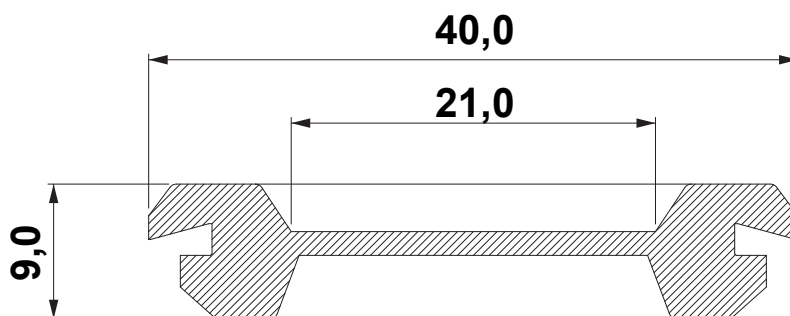

**WORKING TEMPERATURE: -40°C ~ +100°C**  
**CUTOUT: M32**  
**IP RATING: IP54 (IP65 if used as a plug)**  
**FLAMMABILITY: V0 (UL94)**  
**NO. OF CABLE LEAD-THROUGHS: 1**  
**CABLE Ø 1,0 - 21,0 mm**  
**HOLE DIAMETER: Ø 32,5 mm**  
**THICKNESS: 1,0 - 2,0 mm**

				TITLE <b>CABLE GROMMET IP54</b>	
				MATERIAL TPE V0 (UL94)	DATE 28/02/2024
				DRAWN E.B.	
PART NUMBER 18790PS01		DRAWING NUMBER 24.02.28.18790.0.E		COLOR BLACK	CHECK
SIZE A4	SCALE NTS	UNIT mm.	REV A	UNLESS OTHERWISE SPECIFIED TOLERANCE SEE ABOVE	APPROVED