

DIM.	TOL.
5mm DOWN	±0.2
5~20mm	±0.3
20~40mm	±0.4
40~60mm	±0.5
60~100mm	±0.8
100mm UP	±1.0

REVISIONS			
REV	DESCRIPTION	DATE	BY

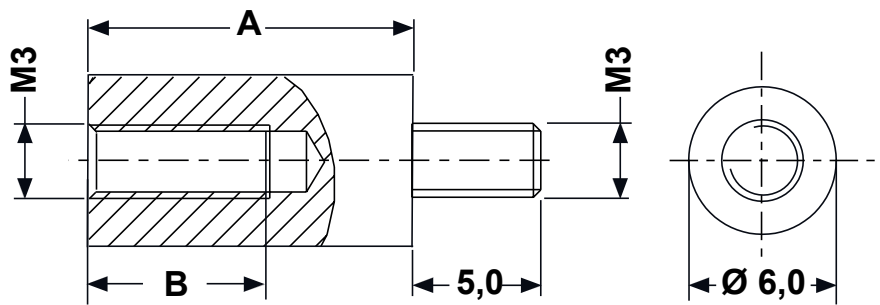

P/N	A	B
10031AA0105.0	5,0	3,0
10031AA0106.0	6,0	4,0
10031AA0107.0	7,0	5,0
10031AA0108.0	8,0	6,0
10031AA0109.0	9,0	7,0
10031AA0110.0	10,0	8,0
10031AA0111.0	11,0	9,0
10031AA0112.0	12,0	10,0
10031AA0113.0	13,0	10,0
10031AA0114.0	14,0	10,0
10031AA0115.0	15,0	10,0
10031AA0116.0	16,0	10,0
10031AA0117.0	17,0	10,0
10031AA0118.0	18,0	10,0
10031AA0119.0	19,0	10,0
10031AA0120.0	20,0	10,0
10031AA0121.0	21,0	10,0
10031AA0122.0	22,0	10,0
10031AA0123.0	23,0	10,0
10031AA0124.0	24,0	10,0
10031AA0125.0	25,0	10,0
10031AA0126.0	26,0	10,0
10031AA0127.0	27,0	10,0
10031AA0128.0	28,0	10,0
10031AA0129.0	29,0	10,0
10031AA0130.0	30,0	10,0
10031AA0131.0	31,0	10,0
10031AA0132.0	32,0	10,0
10031AA0133.0	33,0	10,0

P/N	A	B
10031AA0134.0	34,0	10,0
10031AA0135.0	35,0	10,0
10031AA0136.0	36,0	10,0
10031AA0137.0	37,0	10,0
10031AA0138.0	38,0	10,0
10031AA0139.0	39,0	10,0
10031AA0140.0	40,0	10,0
10031AA0141.0	41,0	10,0
10031AA0142.0	42,0	10,0
10031AA0143.0	43,0	10,0
10031AA0144.0	44,0	10,0
10031AA0145.0	45,0	10,0
10031AA0146.0	46,0	10,0
10031AA0147.0	47,0	10,0
10031AA0148.0	48,0	10,0
10031AA0149.0	49,0	10,0
10031AA0150.0	50,0	10,0
10031AA0151.0	51,0	10,0
10031AA0152.0	52,0	10,0
10031AA0153.0	53,0	10,0
10031AA0154.0	54,0	10,0
10031AA0155.0	55,0	10,0
10031AA0156.0	56,0	10,0
10031AA0157.0	57,0	10,0
10031AA0158.0	58,0	10,0
10031AA0159.0	59,0	10,0
10031AA0160.0	60,0	10,0
10031AA0161.0	61,0	10,0

WORKING TEMPERATURE: -30°C +150°C

		TITLE ROUND METRIC THREADED SPACERS	
		MATERIAL PA66 HB(UL94)	DATE 18/05/2022
PART NUMBER SEE TABLE		DRAWN A.C.	
DRAWING NUMBER 18.05.22.10035.0.E		COLOR BLACK	CHECK
SIZE A4	SCALE NTS	UNIT mm.	REV A
UNLESS OTHERWISE SPECIFIED TOLERANCE SEE ABOVE		APPROVED	