

DIM.	TOL.
5mm DOWN	±0.2
5~20mm	±0.3
20~40mm	±0.4
40~60mm	±0.5
60~100mm	±0.8
100mm UP	±1.0

REVISIONS			
REV	DESCRIPTION	DATE	BY

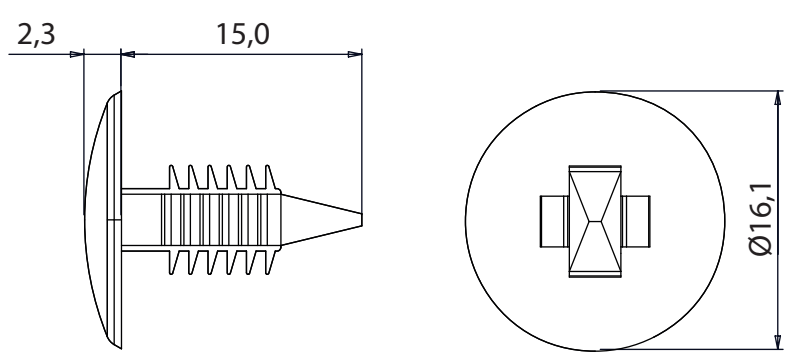

P/N	COLOUR
19553AA01	BLACK
19553AA00	NATURAL

MOUNTING HOLE: Ø6,0
PANEL THICKNESS: 2,5 - 8,0

				TITLE PINE TREE CLIP	
				MATERIAL PA66 V2(UL94)	DATE 17/04/2025
PART NUMBER SEE TABLE				DRAWN E.B.	
				DRAWING NUMBER 25.04.17.19553.E	
SIZE A4				COLOR SEE TABLE	
				CHECK	
SCALE NTS				UNLESS OTHERWISE SPECIFIED TOLERANCE SEE ABOVE	
				APPROVED	
UNIT mm.				REV A	