

DIM.	TOL.
5mm DOWN	±0.2
5~20mm	±0.3
20~40mm	±0.4
40~60mm	±0.5
60~100mm	±0.8
100mm UP	±1.0

REVISIONS			
REV	DESCRIPTION	DATE	BY

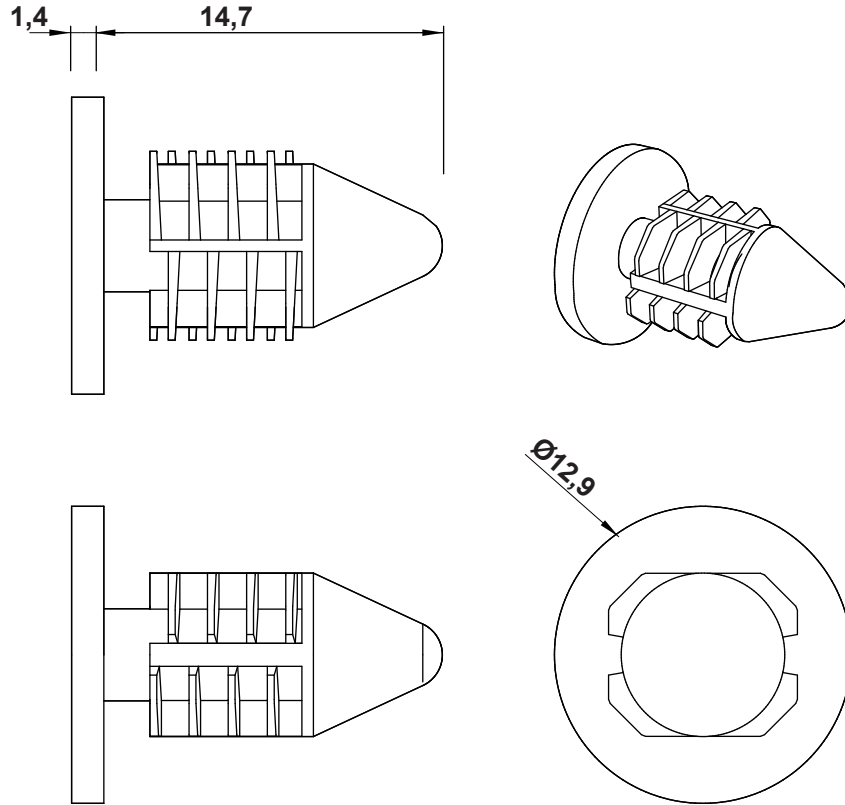

P/N	COLOUR
19558AA01	BLACK
19558AA00	NATURAL

MOUNTING HOLE: Ø7,5
THICKNESS: 6,0-10,0

		TITLE PINE TREE CLIP	
		MATERIAL PA 6.6 V2(UL94)	DATE 17/04/2025
PART NUMBER SEE TABLE		DRAWING NUMBER 25/04/14.19558.E	
DRAWN A.C.		CHECK	
SIZE A4	SCALE 3:1	UNIT mm.	REV A
UNLESS OTHERWISE SPECIFIED TOLERANCE SEE ABOVE		APPROVED	