

DIM.	TOL.
5mm DOWN	±0.2
5~20mm	±0.3
20~40mm	±0.4
40~60mm	±0.5
60~100mm	±0.8
100mm UP	±1.0

REVISIONS			
REV	DESCRIPTION	DATE	BY

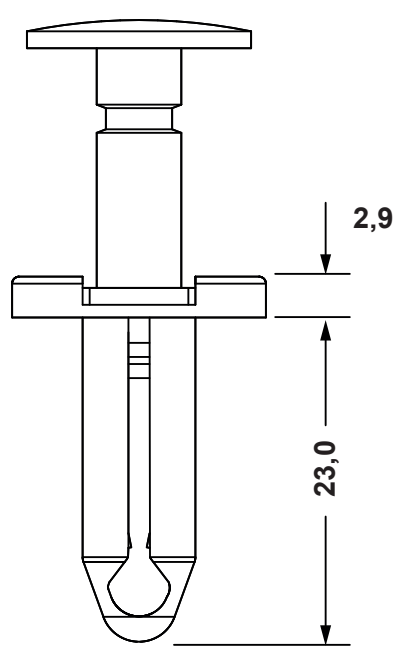
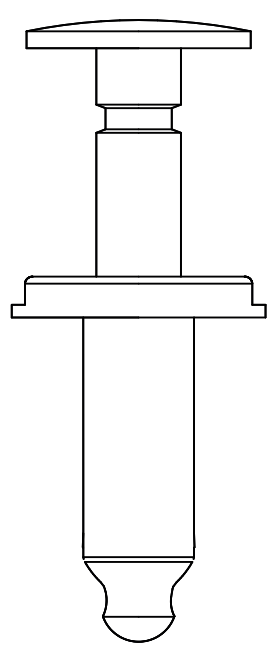
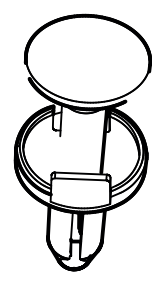
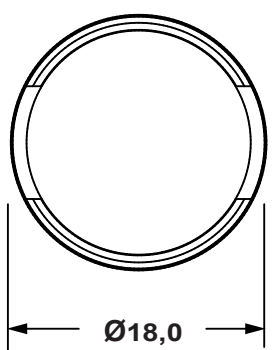

MOUNTING HOLE: Ø8,0
PANEL THICKNESS: 4,0 - 8,0
LENGTH: 23,0

		TITLE PUSH LOCK RIVET	
		MATERIAL PA66 V2(UL94)	DATE 07/05/2025
PART NUMBER 19532AA01		DRAWN A.C.	
DRAWING NUMBER 25/05/07.19532.E		COLOR BLACK	CHECK
SIZE A4	SCALE NTS	UNIT mm.	REV A
UNLESS OTHERWISE SPECIFIED TOLERANCE SEE ABOVE		APPROVED	